

AN ISO 9001:2015
CERTIFIED COMPANY

COMMERCIAL PRODUCTS CATALOGUE



Muskan Equipments Co.

Stylish & Affordable Kitchens..



About Us

Muskan Equipments Co. (MEC) established in 2008 is a very well-known and leading name in The largest Manufacturing & supplying and exporting a wide range of Commercial Kitchen, Refrigeration, Bakery Equipments in India.

From more than 1 decade MEC is providing best service in Manufacturing, Importing and Executing Turn key projects for IT Companies, Healthcare, Hostels, Universities, Hotels, Restaurants, Bars, Banquet Halls, Learning Institutes, Hospitals, Govt. Canteens, Armed Forces Mess, Industrial Canteens, Clubs, Cafeterias etc. in India as well as in other countries. All these client and domains have trusted Muskan Equipments Co. to provide the best Commercial kitchens to fulfill their requirements.

Muskan Equipment's expertise lies in developing an outstanding assortment of Kitchen Equipment. Under the wide range we offer all Commercial Kitchen Equipment. Our Equipment are performing in all type of Industries and domains i.e. Fortune 500 Companies, Hotels, IT Parks, Automobile giants, Govt. Canteens. Our manufactured Products are made of using high-grade SS material and latest methodology adopted from In house Design Teams working with latest Design Software.

Our manufactured products conform to the defined parameters of the all industries and respective domains. These products are widely appreciated for their significant attributes such as longer service life, resistance against corrosion and smooth finish. To meet the diversified demands of the clients, we offer these products in different sizes and specifications. We have combined our love for the Kitchen industry with the World Class quality, craftsmanship, performance and services of the Muskan Equipment brand to give back to those who continue working in a demanding and ever-changing industry. As such, we continue to adapt just as you do, to ensure your needs are not just met, but exceeded.

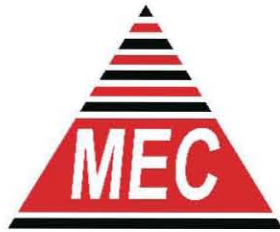

Muskan Equipments Co.

We Fulfill All Your Culinary Needs



Contents

Hot Equipment	4-9
Preparation Equipment	10-13
Exhaust Hood	14-15
Work Table & Sink	16-22
Service Equipment	23-25
Cold Equipment	26-33
Bakery Equipment	34-39
Dishwashing & Imported Equipment	40-45



Muskan Equipments Co.

Cooking Range



BURNERS

Name	Model No.	600 Series	750 Series	900 Series
Single Burner	MEC/1B/600	600x600x600	750x750x600	900x900x600
Two Burner	MEC/2B/850	1200x600x850	1200x750x850	1200x900x850
Three Burner	MEC/3B/850	1800x600x850	1800x750x850	1800x900x850
Four Burner	MEC/4B/850	600x600x850	750x750x850	900x900x850

Hot Equipments



TWO TANK FRYER
MEC/2TF



CHINESE COOKING RANGE
MEC/CCR



CHARCOAL GRILLER
MEC/CG



TWO TANK PASTA BOILER
MEC/2TPB



GRIDDLE PLATE WITH CABINET
MEC/GP/C



CHAPATI PLATE WITH PUFFER
MEC/CPC



DOSA / HOT PLATE
MEC/DP/HP



Muskan Equipments Co.



SS Tandoor



Round Gas Tandoor
MEC/TND/RG



Square Coal Tandoor
MEC/TND/C



Square Gas Tandoor
MEC/TND/G



Round Coal Tandoor
MEC/TND/RC



Muskan Equipments Co.

Roti Machine



**ROUND TYPE
ROTI MACHINE
MEC-RCM/C-1000**



**CONVEYOR
ROTI MACHINE
MEC-CRM/C-1000**



Muskan Equipments Co.

Tilting Bratt Pan



Tilting Bratt Pan (Electric)

MODEL	MEC-TBP/100 (E)	MEC-TBP/150 (E)	MEC-TBP/200 (E)	MEC-TBP/300 (E)
Capacity	100L	150L	200L	300L
Dimension	1200 x 900 x 1000	1250 x 1000 x 1000	1350 x 1000 x 1000	1650 x 1000 x 1000
Electric Load	10 kw	15 kw	20 kw	30 kw
Voltage	380v/50Hz	380v/50Hz	380v/50Hz	380v/50Hz
Water Inlet	Yes	Yes	Yes	Yes
Valve Dia	50 mm	50 mm	75 mm	75 mm
Material	SS-304/430	SS-304/430	SS-304/430	SS-304/430
Tilting Provision	Yes	Yes	Yes	Yes



Tilting Bratt Pan (Gas)

MODEL	MEC-TBP/ 100 (G)	MEC-TBP/ 150 (G)	MEC-TBP/ 200 (G)	MEC-TBP/ 300 (G)
Capacity	100L	150L	200L	300L
Dimension	1200 x 900 x 1000	1350 x 1000 x 1000	1350 x 1000 x 1000	1650 x 1000 x 1000
Gas	Lpg / Png	Lpg / Png	Lpg / Png	Lpg / Png
Water Inlet	Yes	Yes	Yes	Yes
Valve Dia	50 mm	50 mm	75 mm	75 mm
Material	SS-304	SS-304	SS-304	SS-304
Tilting Provision	Yes	Yes	Yes	Yes

Tilting Boiler

Tilting Boiler (Electric)



MODEL	MEC-BT/100 (E)	MEC-BT/150 (E)	MEC-BT/200 (E)	MEC-BT/300 (E)
Capacity	100L	150L	200L	300L
Dimension	1200 x 900 x 1000	1250 x 1000 x 1000	1350 x 1000 x 1000	1650 x 1000 x 1000
Electric Load	10 kw	15 kw	20 kw	30 kw
Voltage	380v/50Hz	380v/50Hz	380v/50Hz	380v/50Hz
Water Inlet	Yes	Yes	Yes	Yes
Valve Dia	50 mm	50 mm	75 mm	75 mm
Material	SS-304/430	SS-304/430	SS-304/430	SS-304/430
Tilting Provision	Yes	Yes	Yes	Yes



Tilting Boiler (Gas)

MODEL	MEC-BT/100 (G)	MEC-BT/150 (G)	MEC-BT/200 (G)	MEC-BT/300 (G)
Capacity	100L	150L	200L	300L
Dimension	1200 x 900 x 1000	1250 x 1000 x 1000	1350 x 1000 x 1000	1500 x 1000 x 1000
Gas	Lpg / Png	Lpg / Png	Lpg / Png	Lpg / Png
Water Inlet	Yes	Yes	Yes	Yes
Valve Dia	50 mm	50 mm	75 mm	75 mm
Material	SS-304	SS-304	SS-304	SS-304
Tilting Provision	Yes	Yes	Yes	Yes



Muskan Equipments Co.

Vegetable Washer

About : The Product

Our vegetable washer is competent to save more than 60% of the water in comparison to the leading manufacturers in our industry.

The washer itself includes all the necessary measures to safeguard the operator such as a sealed Top cover, Waterproof Switches with Emergency Stop Function.

“Industrial Standard SS 304 complete structure”



VEGETABLE WASHER (TILTING TYPE)

MODEL	MEC-TVW-300	MEC-TVW-500 (G)
Tank Capacity	300L	500L
Capacity/Lot	50kg	100kg
Overall Size	1400 x 1000 x 850mm	1825 x 1000 x 850mm
Water Inlet	1"	1"
Water Outlet	50mm	50mm
Electric load	1.5kw	2kw
Voltage	440v/3Ph	440v/3Ph
Control Panel	Front	Front
Basket Size	925 x 700 x 575mm	1225 x 700 x 575mm

Vegetable Cutter

About : The Product

An all-in-one multi-functional veg-cutter to slice, chop, dice, or julienne vegetables and greens. Comes with a belt feed and hopper feed system at opposite ends which can be used simultaneously. Special vegetable belt cutting cum Dicing Machine delivered with SS Guide. SS Finish fitted with a Conveyor Belt for Slicing Application controlled by inverter and has Cast Alloy Feeder for Dicing inbuilt in the machine.



MULTI FUNCTIONAL CONVEYOR VEGETABLE CUTTER

Model	MEC-M-CVC-1000
Capacity	800-1200kg/per hr*
Power	1.75kw
Voltage	220v/1ph
Dimension	1200 x 600 x 1100mm
Material	Stainless Steel





Muskan Equipments Co.

Potato Peeler

Potato Peeler (Premium Series)



POTATO PEELER (PREMIUM SERIES)

Model	MEC-PP-10(ps)	MEC-PP-20(ps)	MEC-PP-30(ps)
Capacity	10 Kg	20 Kg	30 Kg
Efficiency	300-500 kg/hr	600-800 kg/hr	1200-1500 kg/hr
Power	1hp	2hp	2hp
Voltage	220v	220v	220v
Dimension	500 x 500 x 800	600 x 600 x 850	600 x 600 x 1000
Water Inlet	Yes	Yes	Yes



Potato Peeler (Economical Series)



POTATO PEELER (ECONOMICAL SERIES)

Model	MEC-PP-10	MEC-PP-20	MEC-PP-30
Capacity	10 Kg	20 Kg	30 Kg
Efficiency	200-300 kg/hr	500-600 kg/hr	800-1000 kg/hr
Power	1hp	2hp	2hp
Voltage	220v	220v	220v
Dimension	500 x 500 x 800	600 x 600 x 850	600 x 600 x 1000
Water Inlet	Yes	Yes	Yes

Preparation Equipments



MEAT MINCER



DOUGH KNEADER

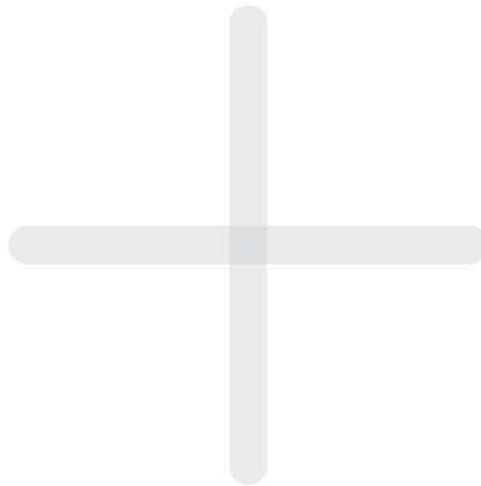

PULVERIZER



WET MASALA GRINDER



Muskan Equipments Co.

Exhaust Hood

EXHAUST HOOD HOOD SYSTEM OVERVIEW

Our exhaust hood removes airborne grease, combustion products, fumes, smoke, heat, and steam from the air by evacuation of the air and filtration. The exhaust hoods equipped with our centrifugal up blast fans or blowers will significantly reduce odors and improve the indoor air quality inside your kitchen.



SS EXHAUST HOOD WITH FRONT TROUGH FRESH AIR SYSTEM AND SS CYCLONE FILTERS

MEC/EXHAUST/HOOD

ADVANTAGE

- Stainless steel 304
- 65 LUX Lights
- Thickness 1.0/1.2mm
- Removable Grease Collector Tray

All visible surfaces are ultra-fine grain polished to 320 grit. Exhaust Hood is cut punched and folded into sub section of up to 300mm in length and factory assembled by means of computer controlled seam welds and non-

mechanical firings. Joints are provided with internal cover plates so that no joints or mechanical firings are visible. All metal edges are rolled smoothly and are free from sharp edges and projections.

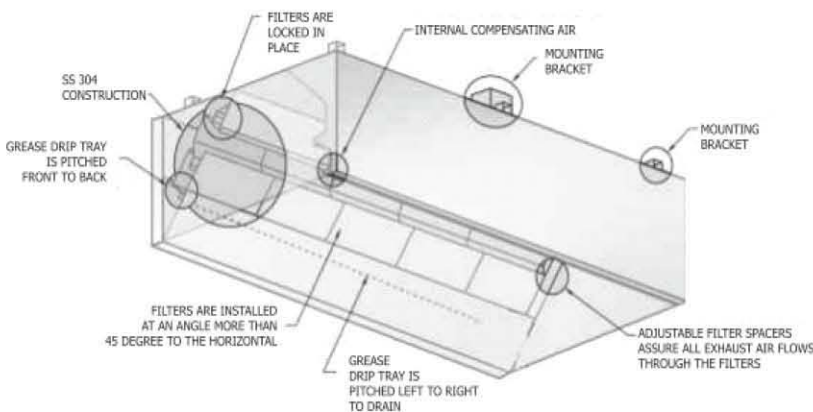

Ventilation Fans

Axial Fan

MEC/AXIAL-FAN

Our axial fan

causes gas to flow through it in an axial direction, parallel to the shaft about which the blades rotate. The flow is axial at entry and exit. The fan is designed to produce a pressure difference, and hence force, to cause a flow through the fan



Exhaust Blower

MEC/ECHAUST-BLOWER

Our Blowers

serve two main functions: cooling and exhaust air flow. Although unit designs range from simple and complex, our blowers consist of a fan-like apparatus.



Air Washers

MEC/Air Washers

Our Air Washers

is used for air purification, humidification, and cooling. Its primary function is to improve indoor air quality by removing pollutants such as dust, allergens, and odors from the air.





Muskan Equipments Co.

Work Tables

WORK TABLE WITH SINGLE UNDER SHELVE



600 SERIES

Code	Dimensions(MM)
MEC-WT1U/S6-900	900 x 600 x 850+150
MEC-WT1U/S6-1050	1050 x 600 x 850+150
MEC-WT1U/S6-1200	1200 x 600 x 850+150
MEC-WT1U/S6-1350	1350 x 600 x 850+150
MEC-WT1U/S6-1500	1500 x 600 x 850+150
MEC-WT1U/S6-1800	1800 x 600 x 850+150
MEC-WT1U/S6-2100	2100 x 600 x 850+150
MEC-WT1U/S6-2400	2400 x 600 x 850+150

750 SERIES

Code	Dimensions(MM)
MEC-WT1U/S75-900	900 x 750 x 850+150
MEC-WT1U/S75-1050	1050 x 750 x 850+150
MEC-WT1U/S75-1200	1200 x 750 x 850+150
MEC-WT1U/S75-1350	1350 x 750 x 850+150
MEC-WT1U/S75-1500	1500 x 750 x 850+150
MEC-WT1U/S75-1800	1800 x 750 x 850+150
MEC-WT1U/S75-2100	2100 x 750 x 850+150
MEC-WT1U/S75-2400	2400 x 750 x 850+150

Work Tables

WORK TABLE WITH DOUBLE UNDER SHELVE



<u>600 SERIES</u>	
Code	Dimensions(MM)
MEC-WT2U/S6-900	900 x 600 x 850+150
MEC-WT2U/S6-1050	1050 x 600 x 850+150
MEC-WT2U/S6-1200	1200 x 600 x 850+150
MEC-WT2U/S6-1350	1350 x 600 x 850+150
MEC-WT2U/S6-1500	1500 x 600 x 850+150
MEC-WT2U/S6-1800	1800 x 600 x 850+150
MEC-WT2U/S6-2100	2100 x 600 x 850+150
MEC-WT2U/S6-2400	2400 x 600 x 850+150

<u>750 SERIES</u>	
Code	Dimensions(MM)
MEC-WT2U/S75-900	900 x 750 x 850+150
MEC-WT2U/S75-1050	1050 x 750 x 850+150
MEC-WT2U/S75-1200	1200 x 750 x 850+150
MEC-WT2U/S75-1350	1350 x 750 x 850+150
MEC-WT2U/S75-1500	1500 x 750 x 850+150
MEC-WT2U/S75-1800	1800 x 750 x 850+150
MEC-WT2U/S75-2100	2100 x 750 x 850+150
MEC-WT2U/S75-2400	2400 x 750 x 850+150



Muskan Equipments Co.

Work Tables

Work Table with Garbage Chute



600 SERIES

Code	Dimensions(MM)
MEC-WTGC/S6-900	900 x 600 x 850+150
MEC-WTGC/S6-1050	1050 x 600 x 850+150
MEC-WTGC/S6-1200	1200 x 600 x 850+150
MEC-WTGC/S6-1350	1350 x 600 x 850+150
MEC-WTGC/S6-1500	1500 x 600 x 850+150
MEC-WTGC/S6-1800	1800 x 600 x 850+150
MEC-WTGC/S6-2100	2100 x 600 x 850+150
MEC-WTGC/S6-2400	2400 x 600 x 850+150

750 SERIES

Code	Dimensions(MM)
MEC-WT2U/S75-900	900 x 750 x 850+150
MEC-WT2U/S75-1050	1050 x 750 x 850+150
MEC-WT2U/S75-1200	1200 x 750 x 850+150
MEC-WT2U/S75-1350	1350 x 750 x 850+150
MEC-WT2U/S75-1500	1500 x 750 x 850+150
MEC-WT2U/S75-1800	1800 x 750 x 850+150
MEC-WT2U/S75-2100	2100 x 750 x 850+150
MEC-WT2U/S75-2400	2400 x 750 x 850+150

Work Table

Work Table with Single Sink

600 SERIES

Code	Dimensions(MM)
MEC-WTS/S6-900	900 x 600 x 850+150
MEC-WTS/S6-1050	1050 x 600 x 850+150
MEC-WTS/S6-1200	1200 x 600 x 850+150
MEC-WTS/S6-1350	1350 x 600 x 850+150
MEC-WTS/S6-1500	1500 x 600 x 850+150
MEC-WTS/S6-1800	1800 x 600 x 850+150
MEC-WTS/S6-2100	2100 x 600 x 850+150
MEC-WTS/S6-2400	2400 x 600 x 850+150



700 SERIES

Code	Dimensions(MM)
MEC-WTS/S7-900	900 x 700 x 850+150
MEC-WTS/S7-1050	1050 x 700 x 850+150
MEC-WTS/S7-1200	1200 x 700 x 850+150
MEC-WTS/S7-1350	1350 x 700 x 850+150
MEC-WTS/S7-1500	1500 x 700 x 850+150
MEC-WTS/S7-1800	1800 x 700 x 850+150
MEC-WTS/S7-2100	2100 x 700 x 850+150
MEC-WTS/S7-2400	2400 x 700 x 850+150

750 SERIES

Code	Dimensions(MM)
MEC-WTS/S75-900	900 x 750 x 850+150
MEC-WTS/S75-1050	1050 x 750 x 850+150
MEC-WTS/S75-1200	1200 x 750 x 850+150
MEC-WTS/S75-1350	1350 x 750 x 850+150
MEC-WTS/S75-1500	1500 x 750 x 850+150
MEC-WTS/S75-1800	1800 x 750 x 850+150
MEC-WTS/S75-2100	2100 x 750 x 850+150
MEC-WTS/S75-2400	2400 x 750 x 850+150

Sink Unit

Single Sink Unit

600 SERIES

Code	Dimensions(MM)
MEC-1S/S6-600	600 x 600 x 850+150
MEC-1S/S6-700	700 x 600 x 850+150
MEC-1S/S6-750	750 x 600 x 850+150





Muskan Equipments Co.

Sink Unit

Two Sink Unit

600 SERIES

Code	Dimensions(MM)
MEC-2S/S6-1050	1050 x 600 x 850+150
MEC-2S/S6-1200	1200 x 600 x 850+150
MEC-2S/S6-1350	1350 x 600 x 850+150
MEC-2S/S6-1500	1500 x 600 x 850+150
MEC-2S/S6-1800	1800 x 600 x 850+150



700 SERIES

Code	Dimensions(MM)
MEC-2S/S7-1050	1050 x 700 x 850+150
MEC-2S/S7-1200	1200 x 700 x 850+150
MEC-2S/S7-1350	1350 x 700 x 850+150
MEC-2S/S7-1500	1500 x 700 x 850+150
MEC-2S/S7-1800	1800 x 700 x 850+150



750 SERIES

Code	Dimensions(MM)
MEC-2S/S75-1050	1050 x 750 x 850+150
MEC-2S/S75-1200	1200 x 750 x 850+150
MEC-2S/S75-1350	1350 x 750 x 850+150
MEC-2S/S75-1500	1500 x 750 x 850+150
MEC-2S/S75-1800	1800 x 750 x 850+150



Sink Unit

Three Sink Unit

600 SERIES

Code	Dimensions(MM)
MEC-3S/S6-1350	1350 x 600 x 850+150
MEC-3S/S6-1500	1500 x 600 x 850+150
MEC-3S/S6-1800	1800 x 600 x 850+150
MEC-3S/S6-2100	2100 x 600 x 850+150
MEC-3S/S6-2400	2400 x 600 x 850+150



700 SERIES

Code	Dimensions(MM)
MEC-3S/S7-1350	1350 x 700 x 850+150
MEC-3S/S7-1500	1500 x 700 x 850+150
MEC-3S/S7-1800	1800 x 700 x 850+150
MEC-3S/S7-2100	2100 x 700 x 850+150
MEC-3S/S7-2400	2400 x 700 x 850+150



750 SERIES

Code	Dimensions(MM)
MEC-3S/S75-1350	1350 x 750 x 850+150
MEC-3S/S75-1500	1500 x 750 x 850+150
MEC-3S/S75-1800	1800 x 750 x 850+150
MEC-3S/S75-2100	2100 x 750 x 850+150
MEC-3S/S75-2400	2400 x 750 x 850+150





Muskan Equipments Co.

SS Shelves



Single Overhead Shelf
MEC / OHS / 1



Double Overhead Shelf
MEC / OHS / 2



Double Overhead Shelf
with food Warmer



SS Wall Pipe Shelf
MEC / PPS-01



SS Wall Shelf
MEC / WS-01

Service Equipments



TWO TIER TROLLEY

Code	Description	Dimension(mm)
MEC-2TT	Two Tier Trolley	900 x 600 x 900



THREE TIER TROLLEY

Code	Description	Dimension(mm)
MEC-3S/S6-900	Three Tier Trolley	900 x 600 x 900



PLATFORM TROLLEY

Code	Description	Dimension(mm)
MEC-PT	Platform Trolley	900 x 600 x 900



MARBLE WORK TABLE

Code	Description	Dimension(mm)
MEC-MWT	Marble Top Table	900 x 600 x 850



TEA SNACK TROLLEY

Code	Description	Capacity
MEC-TST	Tea Snack Trolley	Customized



POTATO AND ONION BINS

Code	Description	Capacity
MEC-BIN	Potato and Onion Bins	50-100 kg



Muskan Equipments Co.

Service Equipments



HOT FOOD TROLLEY

MEC/HFT



COLD BAIN MARIE

MEC/BM-C



SINGLE CHAMBER PLATE WARMER

MEC/PW/50



HOT BAIN MARIE

MEC/B/H/C



DOUBLE CHAMBER PLATE WARMER

MEC/2PW/100



HOT BAIN MARIE WITH HOT CASE

MEC/B/H+HC

Service Equipments



Four Seater Dining Table
MEC-DT-4S



Six Seater Dining Table
MEC-DT-6S



Eight Seater Dining Table
MEC-DT-8S



Muskan Equipments Co.

Display Counter



OPEN DECK CHILLER AND COLD DISPLAY COUNTER







Model	MEC-DC-900	MEC-DC-1200	MEC-DC-1500
Capacity	350L	500L	1000L
Temperature(°C)	2-8	2-8	2-8
Glass	Heated	Heated	Heated
Shelves	2 & 3	2 & 3	6
Voltage	220V/50HZ	220V/50HZ	220V/50HZ
Dimension(mm)	900 x 730 x 1300	1200 x 730 x 1300	1500 x 750 x 1900

GLASS DISPLAY UNIT

Model	MEC-TCC-600(HOT)	MEC-TCC-600(COLD)
Capacity	85L	85L
Shelves	2	2
Temperature (°C)	40-65	2-8
Refrigerant	-----	R134a/R600a
Rated Input Power(W)	1100	230/160
Overall Dimension(mm)	660 x 530 x 730	660 x 530 x 730

Wine Chiller



-  adjustable wood shelves
-  self-evaporation water tray
-  tempered glass door
-  digital control
-  inner LED light
-  lock fitted



- **Double temperature cabinets**
- **Dynamic cooling**
- **Inside fan for ventilation, achieving even temperature**
- **#304 stainless steel glass door, one layer tempered for safety, anti-UV**
- **Elegant blue LED inside light for illumination**
- **Ball bearing sliding shelves**
- **Digital controller with blue LED display & defrost timer**
- **#304 stainless steel handle**
- **Aluminium buttons**

Model	Dimension (mm)	Capacity	Bottle Cap.	Temp.	Power Consumption	Power Supply	No. of shelves	Weight (Kg)
CM - 38	435x580x1020	125	35-50	3~22°C	0.74KW.h/24h	220v/50Hz	7	46/43
CM - 66	635x580x1020	190	66-80	3~22°C	1KW.h/24h	220v/50Hz	7	56/53.5
CM - 180	650x680x1840	480	181-210	3~22°C	1.4KW.h/24h	220v/50Hz	8	117/112



Muskan Equipments Co.

Back Bar Bottle Chiller



- Inside fan for ventilation, achieving even temperature
- Inside light for illumination
- Replaceable gasket for hygiene
- Adjustable chrome shelves for merchandising
- Carel digital controller with LED display & defrost timer
- Embossed aluminum interior
- Textured exterior body, avoids scratch
- Elegant extruded handle
- Double glazing. self-closing glass door, one layer tempered for safety
- Inside drain hole. self-evaporation water tray convenient
- Available at various heights 90cm, 87cm and 84cm
- 2 adjustable legs



adjustable wood shelves



self-evaporation water tray



tempered glass door



digital control



inner LED light



lock fitted

BACK BAR BOTTLE COUNTER

MODEL	Cooling System	Temp. Range	Volume	Product	Packages	Net	Gross
CM-100	Single Door	0-210 °C	130 L	600 x 520 x 900	650 x 570 x 980	46	50
CM-200	Double Door	0-10 °C	210 L	900 x 520 x 900	955 x 570 x 980	62	69
CM-300	Triple Door	0-10 °C	320 L	1350 x 520 x 900	1400 x 570 x 980	82	90
CM-200S	Double Door	0-210 °C	210 L	900 x 520 x 900	955 x 570 x 980	62	69
CM-300S	Triple Door	0-10 °C	320 L	1350 x 520 x 900	955 x 570 x 980	82	90

Under Counter Freezer Refrigerator



Two Door Undercounter

TECHNICAL DATA

MODEL	MEC-R1350L2
Dimension (mm) W*D*H	1350 x 700 x 850
Net Volume (L)	260L
Temperature Range (°C)	-2 ~ +10
Ambient Temperature (°C)	43(T)
Rated Power Input (W)	350
Refrigerant	R134a
Cooling Type	Ventilated
Defrosting Type	Automatic



Two Glass Door Undercounter

TECHNICAL DATA

MODEL	MEC-R1350G
Dimension (mm) W*D*H	1350 x 700 x 850
Net Volume (L)	260L
Temperature Range (°C)	0 ~ +10
Ambient Temperature (°C)	32(N)
Rated Power Input (W)	350
Refrigerant	R134a
Cooling Type	Ventilated
Defrosting Type	Automatic



Two Door Undercounter

TECHNICAL DATA

MODEL	MEC-F1350L2
Dimension (mm) W*D*H	1350 x 700 x 850
Net Volume (L)	260L
Temperature Range (°C)	-15 ~ -22
Ambient Temperature (°C)	43(T)
Rated Power Input (W)	600
Refrigerant	R400a
Cooling Type	Ventilated
Defrosting Type	Automatic





Muskan Equipments Co.

Under Counter Freezer Refrigerator



Three Door Undercounter

TECHNICAL DATA

MODEL	MEC-R1800L3
Dimension (mm) W*D*H	1800 x 700 x 850
Net Volume (L)	400L
Temperature Range (°C)	-2~ +10
Ambient Temperature (°C)	43(T)
Rated Power Input (W)	360
Refrigerant	R134a
Cooling Type	Ventilated
Defrosting Type	Automatic



Three Glass Door Undercounter

TECHNICAL DATA

MODEL	MEC-R1800G
Dimension (mm) W*D*H	1800 x 700 x 850
Net Volume (L)	400L
Temperature Range (°C)	0~ +10
Ambient Temperature (°C)	32(N)
Rated Power Input (W)	700
Refrigerant	R134a
Cooling Type	Ventilated
Defrosting Type	Automatic



Three Door Undercounter

TECHNICAL DATA

MODEL	MEC-F1800L3
Dimension (mm) W*D*H	1800 x 700 x 850
Net Volume (L)	400L
Temperature Range (°C)	-15~ -22
Ambient Temperature (°C)	43(T)
Rated Power Input (W)	700
Refrigerant	R404a
Cooling Type	Ventilated
Defrosting Type	Automatic



Under Counter Freezer Refrigerator



Pizza Preparation Unit

TECHNICAL DATA	
MODEL	MEC-R2025D7PZ
Dimension (mm) W*D*H	2025 x 800 x 990
Net Volume (L)	550L
Temperature Range (°C)	0~ +10
Ambient Temperature (°C)	43(T)
Rated Power Input (W)	360
Refrigerant	R134a
Cooling Type	Ventilated
Defrosting Type	Automatic



Pizza Preparation Unit

TECHNICAL DATA	
MODEL	MEC-R1500PH
Dimension (mm) W*D*H	1500 x 800 x 1070
Net Volume (L)	360L
Temperature Range (°C)	0~ +10
Ambient Temperature (°C)	43(T)
Rated Power Input (W)	360
Refrigerant	R134a
Cooling Type	Ventilated
Defrosting Type	Automatic



Salad Counter

TECHNICAL DATA	
MODEL	MEC-AS900
Dimension (mm) W*D*H	900 x 700 x 850
Net Volume (L)	250L
Temperature Range (°C)	0~ +10
Ambient Temperature (°C)	32(N)
Rated Power Input (W)	504
Refrigerant	R134a
Cooling Type	Ventilated
Defrosting Type	Automatic





Muskan Equipments Co.

Refrigeration Equipments



FOUR DOOR REFRIGERATOR			
MODEL	MEC-1.2TN4	MEC-1.2BT4	MEC-1.2TNG4
Dimension	1400 x 820 x 2050	1400 x 820 x 2050	1400 x 820 x 2050
Volume	1220L	1220L	1220L
Temperature C	-2 ~ +10	-15 ~ -22	0 ~ +10
Ambient Temp.	43(T)	43(T)	32(N)
Rated Power i/p	560	880	560
Refrigerant	R134a	R404a	R134a
Defrosting Type	Automatic	Automatic	Automatic



TWO DOOR REFRIGERATOR			
MODEL	MEC-550TN2	MEC-550BT2	MEC-550TNG2
Dimension	700 x 820 x 2050	700 x 820 x 2050	700 x 820 x 2050
Volume	550L	550L	550L
Temperature C	-2 ~ +10	-10 ~ -22	0 ~ +10
Ambient Temp.	43(T)	43(T)	32(N)
Rated Power i/p	350	750	350
Refrigerant	R134a	R404a	R134a
Defrosting Type	Automatic	Automatic	Automatic



BLAST CHILLER			
MODEL	GN550TN2	BCF20	BCF40
Dimension	710 x 700 x 555	800 x 800 x 1000	800 x 800 x 1800
Volume	60L	90L	230
Temperature C	-35 ~ +3	-35 ~ +3	-35 ~ +3
Ambient Temp.	43(T)	32(N)	32(N)
Rated Power i/p	860	860	2400
Refrigerant	R404a	R404a	R404a
Defrosting Type	Automatic	Automatic	Automatic

Refrigeration Equipments



Six Door Refrigerator
MEC-6D-R
Customizable Sizes



Cold Room
MEC-CD
Customizable Sizes



Water Cooler
Customizable Sizes





Muskan Equipments Co.

Table Top Items



SINGLE GRILLER/ JUMBO GRILLER
BT-CG-811 / BT-CG-811E



DOUBLE CONTACT GRILLER
BT-CG-813



ELECTRIC FRYER
BT-EF-6L (6/8/11 Ltr.)



DOUBLE ELECTRIC FRYER
BT-EF-6L2 (6/8/11 Ltr.)



ELC. CONVEYOR TOASTER
BT-CT-150 (150/30/450)



POP-UP TOASTER
BT-ETS-4/6



ELECTRIC SALAMANDER
BT-937



AUTO LIFTED SALAMANDER
BT-EF-6L2 (6/8/11 Ltr.)



SHAWARMA MACHINE
BT-791/890

Rotary Oven

Rotary Oven
Can Choose Electric & Gas Trolley Size 18 & 36 Tray

Baking a Wide Range

Bread, Toast, Cookies, Cakes etc.

- Efficient low-energy, super insulation.
- Overheating protection, safe and reliable.
- One operator can save manpower.
- Full Stainless Steel body.
- Computer control panel, simple to operate.
- Steam humidification function.
- Special Designed system to ensure uniform.
- Hot-air and temperature inside the oven.

Inside: 1.5mm thickness stainless steel .

Outside: 1.2mm thickness stainless steel Schn electronic accessories.
High Quality heating tube 135mm thickness



ELECTRIC / GAS ROTARY OVEN				
Model	BT-RO-18(E)	BT-RO-36(E)	BT-RO-18(G)	BT-RO-36(G)
Voltage	380/3/50Hz or 380/3/60Hz	380/3/50Hz or 380/3/60Hz	380/3/50Hz or 380/3/60Hz	380/3/50Hz or 380/3/60Hz
power	30.0 Kw	46.0 Kw	1.5Kw	2.5 Kw
Gas	N/A	N/A	LPG/PNG	LPG/PNG
Temperature	RT 350 °C	RT 350 °C	RT 350 °C	RT 350 °C
Trolley	1	2	1	2
Tray	18	36	18	36
Net Weight(kg)	1600	3200	1600	3200
Dimensions(L*W*H)	1800 x 1700 x 2400	2200 x 2000 x 2400	1800 x 1700 x 2400	2200 x 2000 x 2400



Muskan Equipments Co.

Bakery Range



FLOOR TYPE



TABLE TYPE



DOUGH SHEETER

Model	BT-DS-520B	BT-DS-520	BT-DS-650
Dimension(LxWxH)mm	2080 x 880 x620	2550 x 380 x 1180	2950 x 1100 x 1180
Working Position	2080/620	2550/1180	2950/1180
Maximum Roll Weight	5-7	5-7	6-8
Power(kw)	0.56	0.56	0.75
Conveyor Belt Size	2000 x 500	2000 x 500	2400 x 600
Voltage	220v-380v-50Hz-13HP		
Roller Adjust Gap	1-35mm	1-35mm	1-35mm



BREAD SLICER

Model	BT-DD-30	BT-DD-30A
Dimension(L*W*H)mm	630 x 6300 x 785	675 x 630 x 740
Blade Frame width(mm)	385	485
Output PCS	240 per/hr	240 per/hr
Power(KW)	0.2	0.2
Thickness of Slice(mm)	12	12
Voltage (v)	22v-400v-50/60 Hz -3HP	

Bakery Range



S/S WHISK



S/S BAT



S/S HOOK



SPIRAL MIXER

Model	H20	H30	H50
Dimensions (LxWxH)mm	850 x 490 x 1070	940 x 540 x 1260	1000 x 540 x 1300
Dough Capacity (LTR)	20	30	50
Power (kw)	1.1	1.8	2.2
voltage (v)	22v-400v-50/60 Hz		



PLANETARY MIXER WITH SAFETY GAURD

Model	BM20	BM30	BM40
Dimensions(mm)	460 x 440 x 810	580 x 500 x 995	580 x 500 x 1000
Capacity	20 QT	30 QT	40 QT
Power(kw)	1	1.2	1.5
Rev/Min	92/176/337	87/174/337	87/174/337
Voltage(v)	220v-400v-50/60Hz		



Muskan Equipments Co.

Oven Range

- Upturned glass door with Separate handles for hand protection.
- The separated controlling panel, easy for operation and time control.
- Visible glass window to permit Real-time control of baking conditions.
- The efficient heating tube makes baking more balanced.
- The inner liner is made of plating aluminum plate, which is more durable and tough under high temperature.
- Smoke – absorbing design for the hood to keep the whole machine cleaner.
- Thicken Insulation design to keep the heat inside.



ELECTRIC OVEN

Model NO.	MGE-2Y-4
Temp. Range	0-400 °C
Rated Voltage	380 v
Rated Frequency	50hz
Rated Power Input	9.96kw
Net Weight(kg)	355
Exterior Dimension	1260 x 1360 x 1780



Oven Range



BAKING OVEN / ELECTRIC DECK OVEN / INFRARED DECK OVEN / GAS DECK OVEN

Model	Voltage (v)	Power (Kw)	Capacity	Dimensions(mm)	Chamber Size(mm)	Electric/ Gas
BT-YXD-10C	220	3.2	1 Deck/1 Tray	925 x 570 x 430	640 x 455 x 180	Electric
BT-YXD-20C	220/380	6.6	1 Deck/2 Tray	1260 x 805 x 535	860 x 670 x 220	Electric
BT-YXD-40C	380	13.2	2 Deck/4 Tray	1260 x 805 x 1100	860 x 670 x 220 x 2	Electric
BT-YXD-60C	380	19.8	3 Deck/6 Tray	1260 x 805 x 1515	860 x 670 x 220 x 3	Electric
BT-YXY-20A	220	0.1	1 Deck/2 Tray	1330 x 840 x 615	860 x 670 x 220 x 2	Gas
BT-YXY-40A	220	0.2	2 Deck/4 Tray	1330 x 840 x 1190	860 x 670 x 220 x 2	Gas
BT-YXY-60A	220	0.3	3 Deck/6 Tray	1330 x 840 x 1660	860 x 670 x 220 x 3	Gas



Muskan Equipments Co.

Racks



THREE TIER RACK
MEC-3TR



FOUR TIER RACK
MEC-4TR



FIVE TIER RACK
MEC-5TR



THREE TIER POT RACK
MEC-3TPR



FOUR TIER POT RACK
MEC-4TPR



GLASS RACK
MEC-4-GR

Dishwashing Machines



Hood Type Dishwashing Unit



Conveyor Dishwasher



Under Counter Dishwasher

Under Counter Glasswasher





Muskan Equipments Co.

Ice Cube Machine

- A style element for cocktail drinks. A cool bedding for delicacies. A preserver of life-saving drugs. The list is as long as it is diverse. And to meet your specific usage requirements of ice in the best possible way, you can always rely on the expert, MEC India's leading ice cube making machine companies, collaborates with us, the world's leading ice machine manufacturer, to bring you sophisticated ice-making machines that freeze water and make ice effectively. These machines are hygienic, energy efficient, durable and easy to maintain. Creators uses their expertise and domain knowledge to give you products as per your needs and requirements. And with the Company's widespread service network you can be sure of long life and optimum performance from your machine.



Imported Equipment



CHAFING SQUARE DISHES



COFFEE GRINDER



COFFEE MACHINE SINGLE GROUP



COFFEE MACHINE DOUBLE GROUP



COFFEE MACHINE THREE GROUP



DESKTOP INDUCTION



Muskan Equipments Co.



The Self Cooking Center® India Edition.
Easy to use, makes healthy and delicious food,
saves money.

2 Year Warranty



- Our motivation was and is to make working in a food- service kitchen as easy as possible. That is why we have equipped the new Self Cooking Center India Edition with four intelligent functions and turned it into an assistant that stands for quality, ease of use and efficiency.





Imported Pre-Rinse Unit

MPZ-4DLN-06:

- Mini-PRU: 4" Deck Mount Faucet, B-0107, 6" Swing Nozzle, Lever Handles, Wall Bracket



- 4" deck mount mixing faucet with polished chrome plated brass body,
- Add-on faucet with compression cartridge with spring check and lever handle,
- 6" swing nozzle with stream regulator outlet, 8" riser, 24"
- Flexible stainless steel hose with heat resistant handle,
- 1.15 GPM spray valve, compression cartridges with spring checks, lever handles,
- 1/2" NPT female inlet, 6" adjustable wall bracket, spray valve holder and overhead spring.

B-0133-ADF12-B:

- EasyInstall Pre-Rinse Unit: Spring Action, 8" Wall Mount, 12" Add-On Faucet, Wall Bracket



- 8" wall mount mixing faucet with polished chrome plated brass body,
- Add-on faucet with compression cartridge and lever handle,
- 12" swing nozzle with stream regulator outlet, 18" riser, 44" flexible stainless steel hose with heat resistant handle,
- 1.15 GPM spray valve, compression cartridges with spring checks, lever handles,
- 1/2" NPT female inlets, 6" adjustable wall bracket, spray valve holder and overhead spring.

B-0133-12CRBJST:

- B-0133-12CRBJST: EasyInstall Pre-Rinse, 8" Wall Mount, Ceramas, 12" ADF, B-0107-J, B-0230-K, Tee,



- 8" wall mount mixing faucet with polished chrome plated brass body,
- Add-on faucet with ceramic cartridge and lever handle,
- 12" swing nozzle with stream regulator outlet, 18" riser, 44" flexible stainless steel hose with heat resistant handle and swivel,
- 1.07 GPM spray valve, ceramic cartridges with check valves, lever handles, accessory fitting tee and installation kit with 1/2" NPT male inlets, 6" adjustable wall bracket, spray valve holder and overhead spring.

5F-8WLX12:

- Faucet, Wall Mount, 8" Centers, 12" Swing Nozzle



- 8" wall mount mixing faucet with polished chrome plated brass body,
- 12" equip swing nozzle, ceramic cartridges, equip lever handles
- 1/2" NPT female inlets.
- Certified to ASME A112.18.1/CSA B125.1, NSF 61-Section 9 and NSF 372. Meets ADA ANSI/ICC A117.1 requirements.

5F-4WLX05:

- Equip 4" Wall Mount Faucet w/ 5-1/2" Swivel Gooseneck, 2.2Gpm Aerator



- 4" wall mount mixing faucet with polished chrome plated brass body,
- 5 9/16" equip swivel gooseneck, ceramic cartridges, equip lever handles.
- 1/2" NPT male inlets.
- Certified to ASME A112.18.1/CSA B125.1, NSF 61-Section 9 and NSF 372. Meets ADA ANSI/ICC A117.1 requirements.

B-7245-06:

- Hose Reel, Open, Epoxy Coated Steel, 3/4" x 50' Hose, 7/16" Front Trigger Water Gun



- Open coated heavy duty hose reel, front trigger water gun, 3/4" x 50' industrial grade white hose, ratcheting system, adjustable hose bumper and 3/4" NPT female inlet. Enclosed/Open: Open
- Hose Length: 50ft (15.2 m)
- Hose Size: 3/4 in (19.1 mm)
- Pressure Max: Pressure Max: 125 psi (8.62 bar)
- Pressure Min: Pressure Min: 20 psi (1.38 bar)
- Temperature Max: Temperature Max: 200 F (93.33°C)
- Temperature Min: Temperature Min: 40 F (4.44°C)



Muskan Equipments Co.

Our Valuable Clients

MEC is proud to have a long list of satisfied consumers from all across the spectrum of the industry we are presently working with.

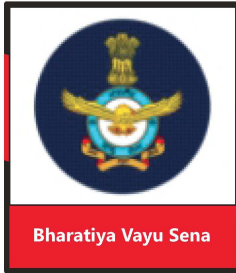

Bharatiya Vayu Sena



Public Works Department Govt. of Rajasthan



Indian Oil



Indian Institute of Technology Gandhi Nagar



IIT Bhubaneswar



IIT Kanpur



BTW

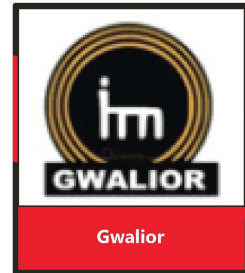

Gwalior



IIM Kozhikode

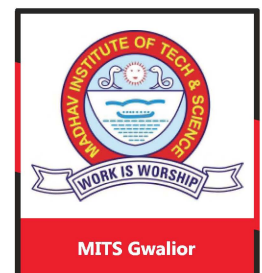

MITS Gwalior



Indian Institute of Technology (New)

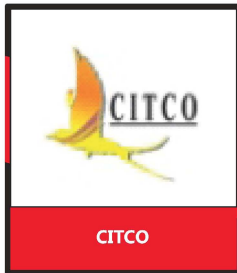

CITCO

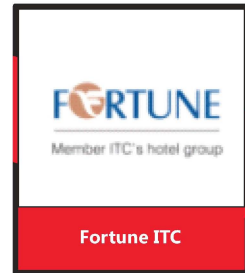

Fortune ITC



NSUT, Dwarka



CPWD

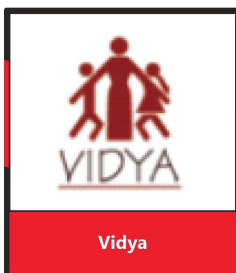

Vidya



IHM PUSA



Maharashtra Tourism



Uttarakhand Police

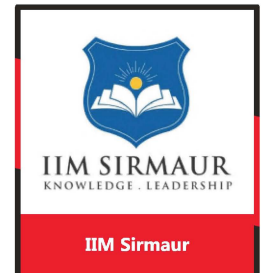

IIM Sirmaur



IHM Bhubaneswar



Malaviya Institute of Technology Jaipur

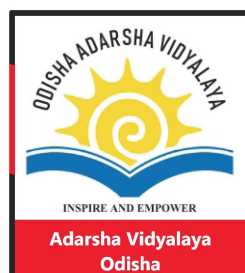

Adarsha Vidyalaya Odisha

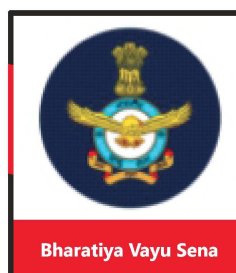

Bharatiya Vayu Sena



IIM Jammu

Our Valuable Clients

MEC is proud to have a long list of satisfied consumers from all across the spectrum of the industry we are presently working with.



Sai Lucknow



Management Development Institute



Dr. Ambedkar Institute of Hotel Management



MMTC



Kerala Institute of Hotel Management



Sports Authority of India

Associate Partners



Electrolux



T & S



Rational



Hatco



Manitowoc



Robot Coupe



NILKAMAL

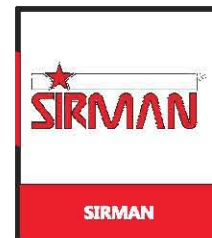

SIRMAN



Sinmag



FIAMMA



ROLLER GRILL



STEELLO



Winter Halter

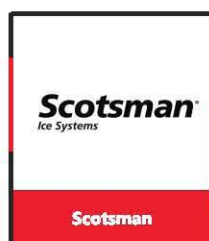

Scotsman



Cool Max



BENTON



Muskan Equipments Co.



Factory Address: NE-235, Sector-3, DSIIDC Bawana, New Delhi – 110039

Contact us: 9350694306, 9891017491, 9667145960

Reach us: muskanequip@gmail.com, muskanequip@yahoo.co.in

Visit us: www.muskanequipments.com, www.muskanequipments.in

Customer Care No. : 9643108206 | **Mail ID :** mechelpdesk3@gmail.com